

Panasonic

1

1 3

!

TyciHiri

(-)
 MiHi-ni4
 ()
 (-)

Model No. NT-GT1

1

Panasonic Corporation

Web Site: <http://panasonic.net>

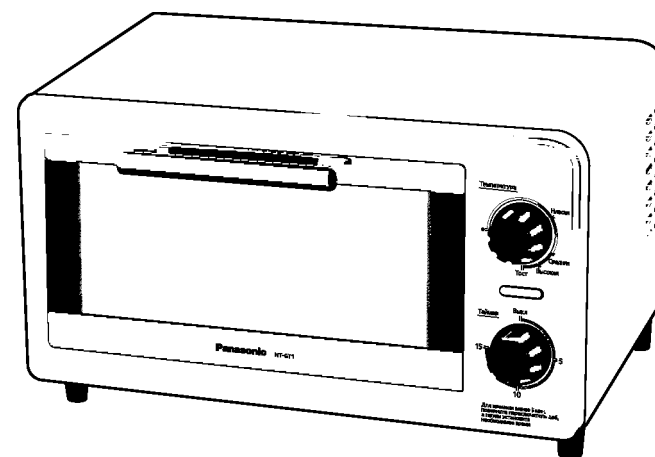

4		14
8	i 1	18
10		20
11	3 í i	21
12		22
13	ТехНННН	23

Panasonic.

1 Panasonic.

- * .
- .
- * « » (4-7).
- .

- * i4e .
- * i c py i i .
- * « » (1 14-17).
- * epi a e i c py i e c ya a iT

1 1 !	24
1 1 1	28
i^o a y T0cini	30
nicipy T0cmi	31
1 1	32
	33

- Panasonic VЛуиН .
- 1 .
- aynci i 1 , TychиНННН
- , « 1 1 1»- 1
- (24-276.)
- TycиНННН



I

0

0

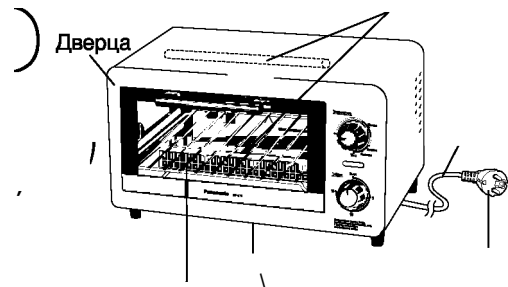

0

I /
(

I
(

I

(

(

(

(

(

*

•

•

*

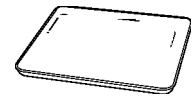



0⁹

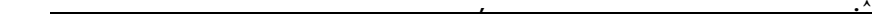

(
0

1^

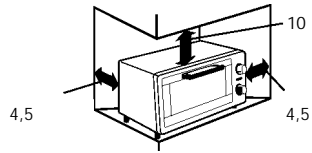

4,5

4,5

»

I

/

(

I

/

(

I

I

(

)

(.12)

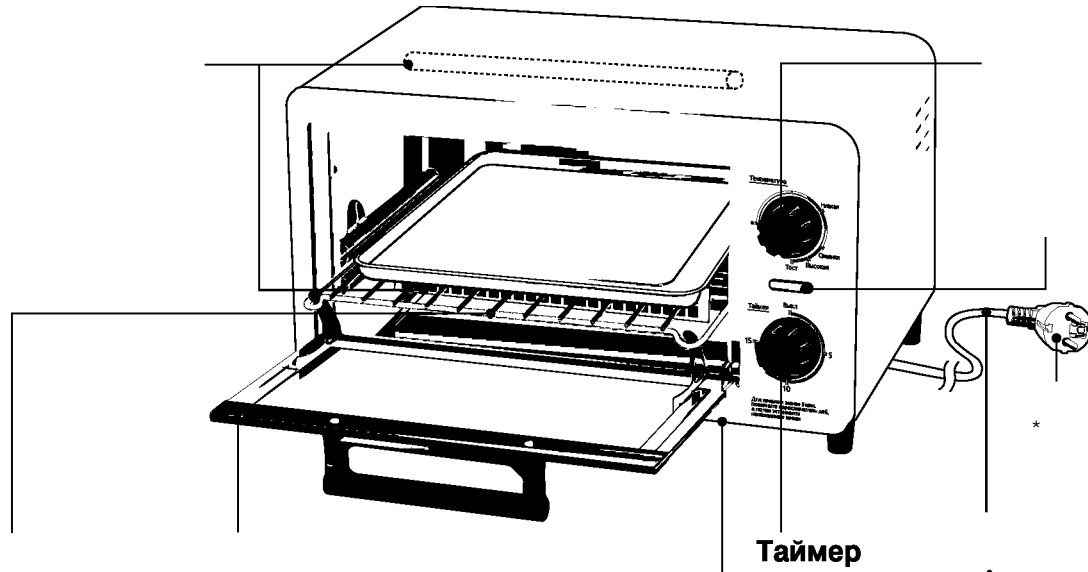

() -

(.12)

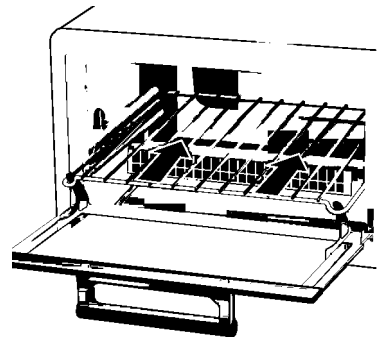
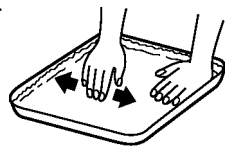
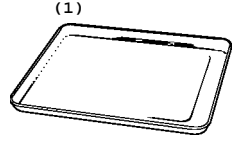

©
(2)

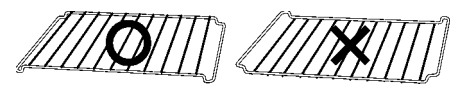

(.12)

1

(8)

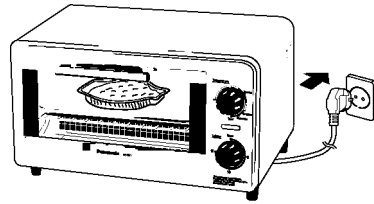

Для пиццы

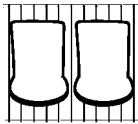

(.11)



5

6

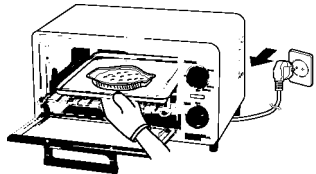

Температура	Рецепт			
Тост	Тост	1 ~ 2	2-4	
Высокая		1-2 (25)	7-10	10
		1 (150)	9-12	10
	()	1 (15-20)	12-14 min.	10
	()	4-8 (25 /1)	12-15	10
	()	4 (40 /1)	13-15	10
		4 (15 (50 /1)	14-15	10
		1-4 ()	8-13	10
		6 (10 (20-30 /1)	9-12	10
Низкая	()	3-6 (50 /1)	3-5	10

15

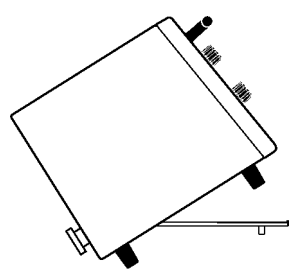
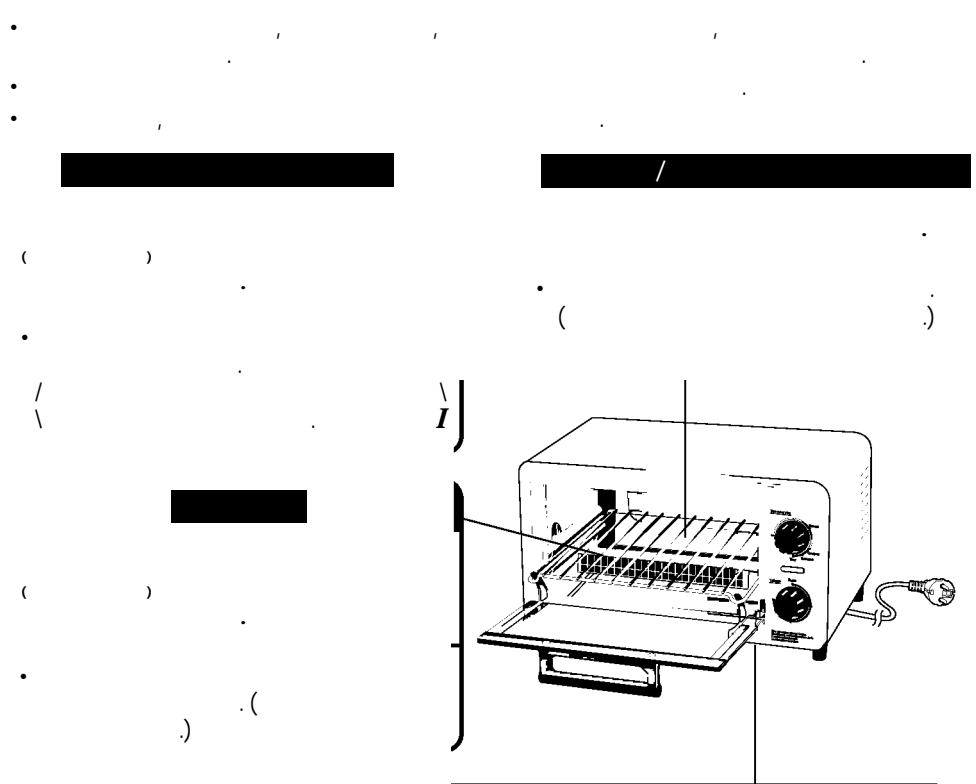

45

	220 - 240	- 50 / 60
	1200	
(x)	37,7	x 27,1 x 21,4
	26,9	x 20,2 6,0
(.)	3,2	
	1,0	
	15	

-2- 3- : ()
 01- , 02- , 12-
 ----- 1- : ()
 0-2010, 1-2011, 2-2012

7

Panasonic Corporation

1

1
1

1 i , 1 , 1 !! 1
! 1
1.

/ ! !

1 1 , 1 .

!

1

0 \ .) ^..... ^
/ \ 1 / \
) , 1 1
(. 1 , 1
> 1 1 1 1 1
()
) / \)
(/ 1)
> / 1 1 . 1 i 1 \
/ \ 1 , 1 1 1 i 1 \
> / 1 , 1
(i . 1 1) 1.

!

1 1

0

/ \ 1 I . \ /
(9 . I .)
1 | 1 .
• 1 1 ,
(.) ^ 1
• (1) 1 .
• 1 1 1 I . 1 .
/ \ 1 / \
I 1 1 (1)
) 3 1 , 1 1 1 1 1
i 1 1 1 1 1 1 1 1 1 1 1 1 1 1
/ \ 1
I I 1 1 . 1
/ \ 1
I 1
1
1 1

i

1 1 1 1 1 1 . (.22)

1

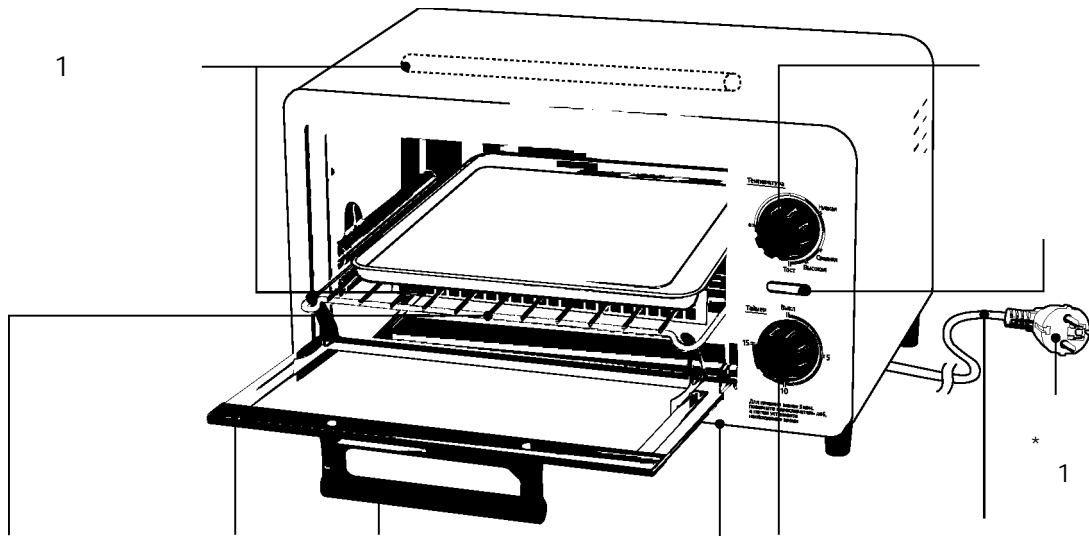

Таймер

()

1 1 1 1 1 .

(.22)

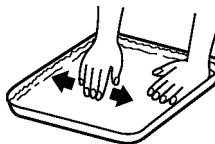
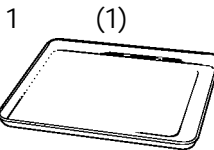

1 1 1

1

1 1 1 1

()

(1 1

I

1 1 1 1

1

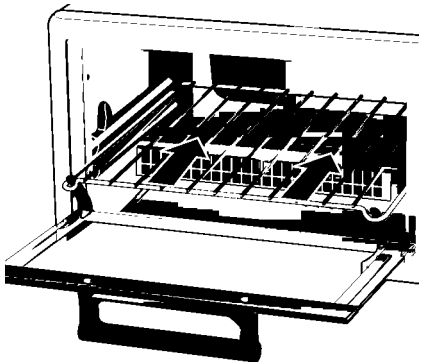

1 1 1 1 / 1

1

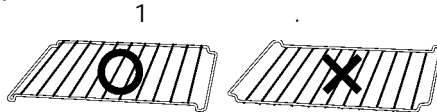

⚠

1 1 1

1.(1 1)

1 1

1.

1

!

1 ! ! ! !

1.(!)

1 ! ! ! ! ! !

!

!

(.22)

! !

!

! 3j !

1 1 1

(1 1- 1.)(.18)

1

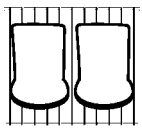

1 1

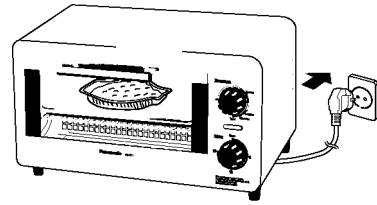

Для піци



1 1 1 1

3 1"



1



1 1 1 1 1 6 /

1 1 1 1 1

1 1 1 1 1 1 1

3 1 1 1 1-1

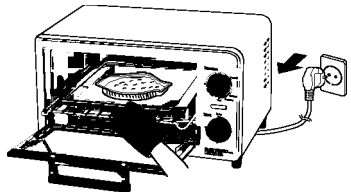

3

1 1

Температура	Рецепт	1 1	1		
Тост (Тост)	Тост	1~2	-	2-4	
	()	1~2 (25)		7-10	>
		1 (150)		9-12	
	(! 1 !)	1 (15-20)		12-14	
	(!!!)	4-8 (25 /)		12-15	
	(!!!)	4 (40 /)		13-15	
		4 (15 / 50)		14-15	
		1-4 (60 /)		8-13	>
		6 (10 / 20-30)		9-12	
Низкая (Низька)	(!!!)	3-6 (50 /)	-	3-5	>

TexHiHi

		220-240 ~50/60		
		1200		
()	! !	37.7	x 27.1	x 21.4
	1 !	26.9	x 20.2	6.0
()		3.2		
		1.0		
		15-		i 1

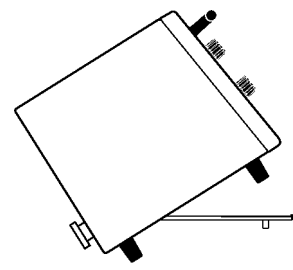
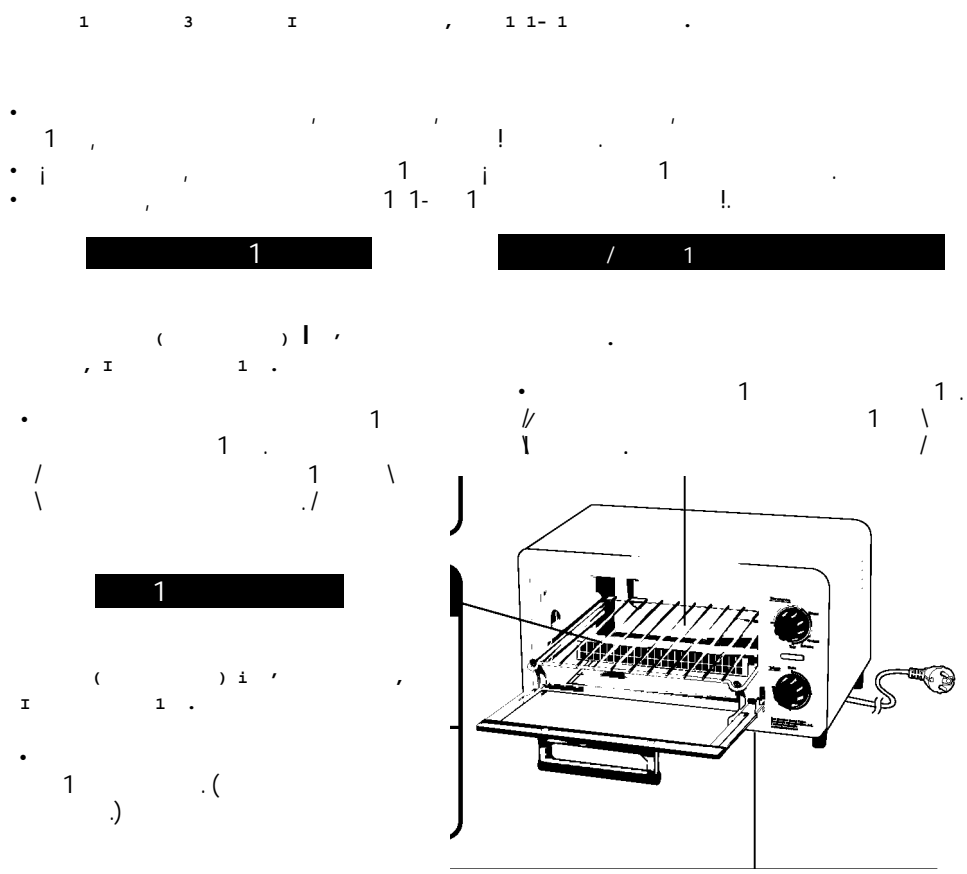

1
 • 1 1 1 1 1- 1 45 1 , 1
 1
 1
 1
 1 1 1 1
 1 1 1 . 1

1 !
 XXX
 X -2- 3- : 1 (!)
 01- 1 , 02- , 12-)
 1- : 1 ()
 0-2010, 1-2011, 2-2012
 1 (!)
 1 1 1 1 1 1 1 1 1 1 1 1
 1 1 1 1 1 1 1 1 1 1 1 1
 1 1 1 1 1 1 1 1 1 1 1 1

1 Panasonic Corporation ! ,
 1 piK.
 1 1 Panasonic
 ! ! ! ! ! : +38-0-(44) 490-38-98
 ! 1 3i 1 i : 0-800-309-880
<http://service.panasonic.ua/>

1 1

! [REDACTED]

!

!

^ _____ 1, | _____ | _____ ^

0⁹ (11 1, 11, 11 1 1, 1, 1.)

111 1, 1
11 1
• (1 1).
• (1).
• (1).
• 1^ 1 (1 1).
• (1 1 !).
• (! ,).

_____ 1, | _____ | _____ ^

0⁹ : 1, 111. 1
1111.

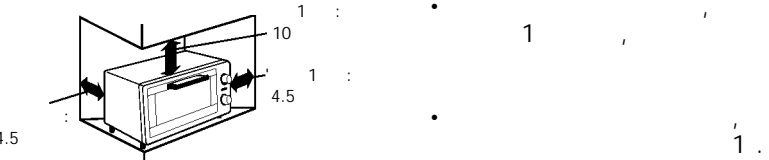

• 1 1 !
•
9 (! 1, 11, !).
•
• (1 1 1).
9, 1 11 1.
• 11
• i 1 11, 11 1

(1^ 1 1.)
(1^ 1 1.)
(1, 1 1).
i 1
• 11 11 1

1

1 1

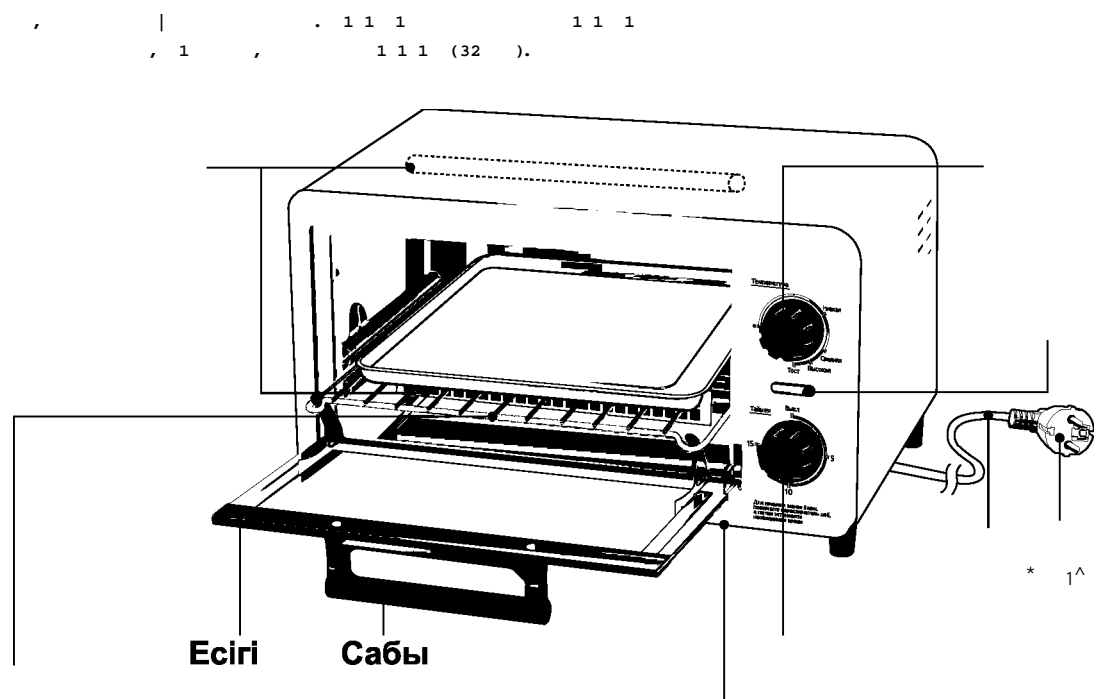

Есігі Сабы



1 1 1

(1)

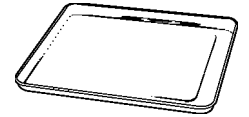

1, 1 1

41 .

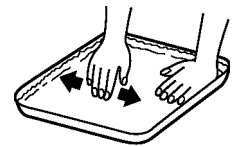

* 1^

! 1.

()-I
 1^01^ 1 1 1 .
 (32) .

(, - i ^ 1).
 1 ^

1 1

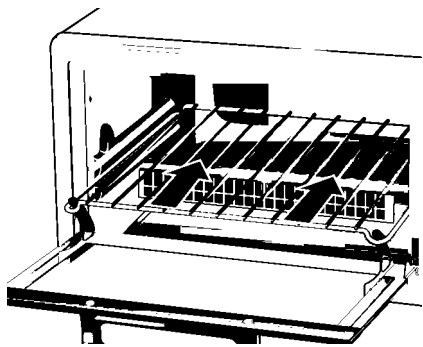

1 1 :
 (2) 1 1 1 1 .
 1 , 1 1 | 1 .

> 1 1 1 1 .
 1 1 1 1 1 ^

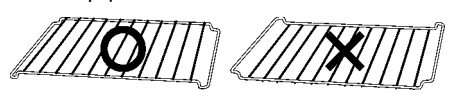

' 1 1 , 1 ^ . (1 1 1 1).
 ' 1 1 1 , 1 1 1 1 -
 ' - 1 1 ^ .
 ' ! 1 , 1 1 1 1 . 1) .
 ' 1 1 1 , 1 1 .
 (1 1 1 ^ . ! ! 1). (32) .

Taci i

1

niciprim

1 1 1

(28)

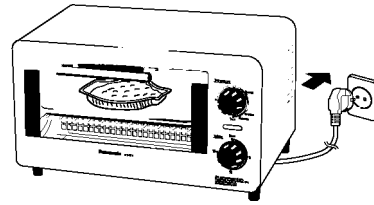

Пицца салуы

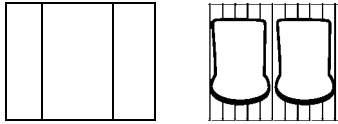

• niciprim 6eTHe

1 1^

1^0

“nicipy recmi”

(31)



1^

• nicipy / 1 1 1 1 1^ 1^

• 5 nicipy 1,6

• 1 1 1 1, ! emiphti3.

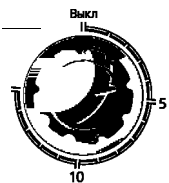

Dicipin

1 1 1. 1^

• Eeikti 1 1 1 1

• 1^ 1, 1

• 1 1 1 1

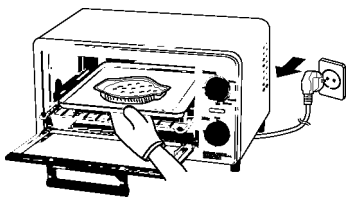

nicipy Tacmi

1 -

1, niciprim

Температура	Рецепт	Саны	niciprim	nicipy
Тост (Қыздыру)	Қыздыру	1 ~ 2		2-4
	nicipy	1~2 (25)		7-10 10
		1 (150)		9-12 10
	()	1 (15-20)		12-14 10
	() ¹	4-8 (25 /)		12-15 10
	()	4 (40 /)		13-15 10
	1	4 (15) (50 /)		14-15 10
	1^	1-4 (60 /)		8-13 10
	()	6 (10) (20-30 /)		9-12 10
Низкая (Аздап)	()	3-6 (50 /)	-	3-5 10

• nicipy ^ 1 - 1

0 1

• 1 1 , nicipmyi nicipy

• 1, nicipy

• 15

• 1 1 1 ^1

• 1 nicipy 1 1

(1 cupin - 1)

1 1

I , - 1 1 .

• 1 , 1 1 .

1

/1 1

- 1 1 1 .

• 1^ (1).

(1 1 1 1).

1 1

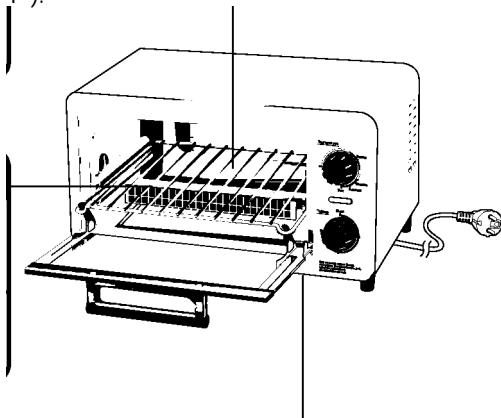

^ . (1).

1 .

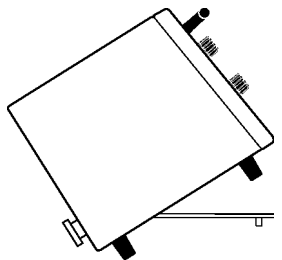

• - 45

, i 1 ^ .

• / 1 1 . 1 , 1 ^

!		220-240 ~ 50/60		
		1200		
!	!	37.7	x 27.1	21.4
	1 1 !	26.9	x 20.2	6.0
()		3.2		
		1.0		
		15		

1
! —
^— 2- !, - ! : ()
01 - , 02- , ... 12-
----- 1- ! : ()
0-2010, 1 -2011, 2-2012

! ! 17 !
!
!
! ! ! , 1 !



1 2.0.02.0052

Declaration of Conformity
 with the requirements of Technical Regulation on the Restriction Of the use of certain
 Hazardous Substances in Electrical and Electronic Equipment
 (adopted by Order No.1057 of Cabinet of Ministers of Ukraine)

Country of Origin: China
 Manufacturer Name: Guang Dong Xinbao Electrical Appliances Holdings Co., Ltd
 Address:
 Zhenghe South Road, Leliu Town, Shunde District, Foshan City, Guangdong Province, China

The Product is in conformity with the requirements of Technical Regulation on the Restriction Of
 the use of certain Hazardous Substances in electrical and electronic equipment (TR on RoHS).

The content of hazardous substance with the exemption
 of the applications listed in the Annex No.2 of TR on RoHS:

1. Lead (Pb) - not over 0,1 wt % or 1000wt ppm;
2. Cadmium (Cd) - not over 0.01wt % or 100wt ppm;
3. Mercury (Hg) - not over 0,1wt % or 1000wt ppm;
4. Hexavalent chromium (Cr6+) - not over 0,1wt % or 1000wt ppm;
5. Polybrominated biphenyls (PBBs) - not over 0,1wt % or 1000wt ppm;
6. Polybrominated diphenyl ethers (PBDEs) - not over 0,1wt % or 1000wt ppm

(1057)

()

1. () - 0,1wt % 1000 ;
 2. (Cd) - 0,01wt % 100 ;
 3. (Hg) - 0,1wt % 1000 ;
 4. () - 0,1wt % 1000 ;
 5. () - 0,1 wt % 1000 ;
 6. (PBDE) - 0,1wt % 1000 ;
- 1 1 1 1
1

(1057 1 MiHicrpiB)

1 1 1 1 ! ()

- BMicT
1. () - 0,1wt % 1000 ;
 2. (Cd) - 0,01wt % 100 ;
 3. () - 0,1wt % 1000 ;
 4. (^^) - 0,1wt % 1000 ;
 5. 1 1 () - 0,1% 1000 ;
 6. 1 1 1 1 (PBDE) - 0,1 wt % 1000 ;